



MINI TANK

Hydraulic swing gate operator for residential use or small condominium
max leaf length up to **10 Ft** or **1000 lbs**



- AC VERSION WITH LOCK IN OPENING AND CLOSING
- AVAILABLE MODEL WITH HYDRAULIC SLOWDOWN FOR A SMOOTH APPROACH OF THE LEAVES IN CLOSING



Battery back-up with fan cooling systems in option for AC motors

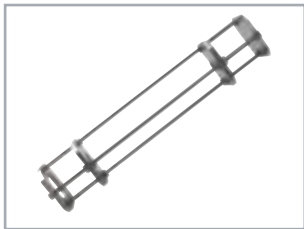

Positive stops in open/close as option



Metal release system PLUS, accessible through lock for max security (optional)



Bypass Valves



Back flange in solid aluminium



External release with SS cable and metal box, in case of power failure (optional)

- ▶ Standard ball joint on all versions for precise adjustment of the stroke
- ▶ Hydraulic operator without lock in opening and closing (SC)
- ▶ Standard aluminium oscillating back fixing fork
- ▶ Extremely silent with hydraulic reliability
- ▶ Anti crushing guaranteed through by-pass valves for max. thrust setting
- ▶ 0.63 inches rod diameter
- ▶ Piston stroke 10.6 inches
- ▶ All-aluminium structure with high-resistance anodising treatment

SPECIFICATIONS	MINI TANK
Power supply	120V- 60Hz
Power Consumption (W)	300W
Operating T° range (F°)	-4°F to 131°F
Opening time 90° (sec)	12 sec
Cycles/hour	40
Duty	Residential
Protection class	IP55
Max leaf length	10 Ft
Max leaf weight	1000 Lbs
Max opening angle (degrees)	120°
Maximum force output	250 daNm
Anti-crushing protection	By pass / Electronic
Slowdown	Electronic
Battery backup	STAR 1000

UNIGATE - I

INVERTER technology



UNIGATE 2I (INVERTER)

- Digital control unit with LCD display
- Adjustable speed
- Adjustable acceleration/deceleration
- Continuous motor cycles
- High strength in slowdown
- Possibility to manage obstacle reverse

Integrated functions on the UNIGATE INVERTER

- 2 relay contacts
- 2 programmable GPIO outputs
- LE card on board for potentiometer
- Relay card on board
- PROBE heater card on board
- Management of two FV inverters for 2 motors or 2 PM modules for 4 motors
- Timer on board with buffer battery and management of 2 time bands
- 2 Ah switching transformer of which about 1.3 Ah free for other accessories



Advantages:

- + Duty cycles
- + Torque
- + Speed (adjustable)
- + one model 90V to 265V

Alternative board: GATE 2 DG

Pre Wired Metal Box

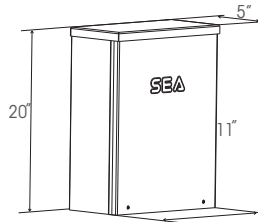

ABS box

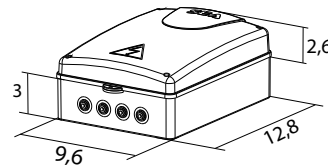

Control Unit GATE 2 DG

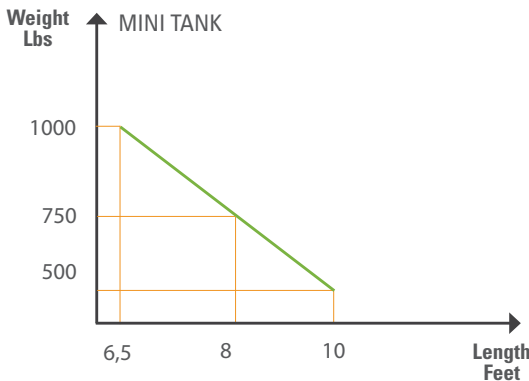

ACCESSORIES



Adjustable back bracket to scrow

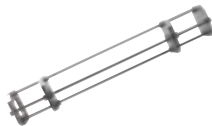

Positive stops



External release with box



Metal release Plus with lock



Sea Com Video Wi Fi Wireless Video Intercom System



Reflex 10k 180°



Magnetic Lock



Kit Probe to manage low T° + card LE + cable 6 Ft



Electric lock Counter-plate



Green oil 1 quarter of bottle



Linear Position Gate with accessories



Battery backup for AC motor 110V

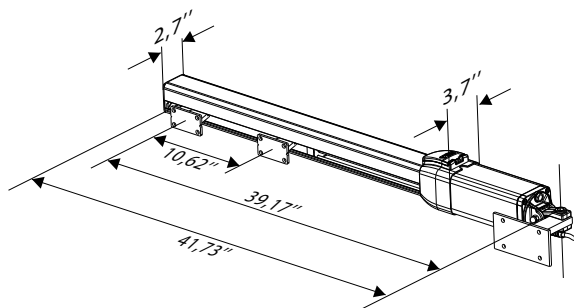

PACKAGE MINI TANK

N.1 MINI TANK

1 pc Carton box 32x9x5H inches - 26 Lbs

40 pcs for pallet